

KZ 1008 – 1012, KZ 1410 – 1412

KZ 1008 – KZ 1012

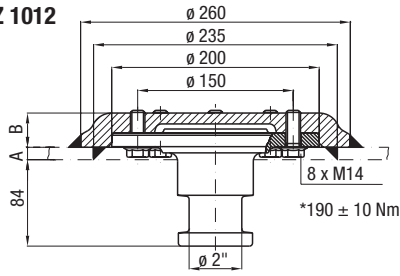

KZ 1410 – KZ 1412

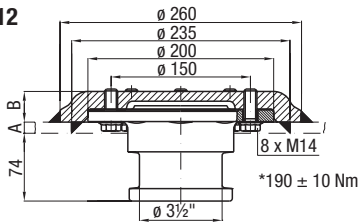

* Torque

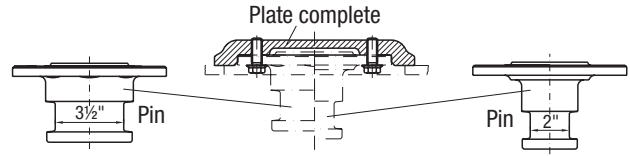

KZ 1412-01

KZ 1012-01

Selection table/Versions available

Order No. King pins, compl.	D value (kN)	A (mm)	B (mm)	Approval (ECE)
KZ 1008	162	8	37	E1 55R-01 0145
KZ 1010	162	10	34	E1 55R-01 0145
KZ 1012	162	12	33	E1 55R-01 0145
KZ 1410	162	10	34	E1 55R-01 0147
KZ 1412	162	12	33	E1 55R-01 0147

Delivery includes

- King pin complete with plate and screws (mounted)

KZ 1016, 1516

KZ 1016

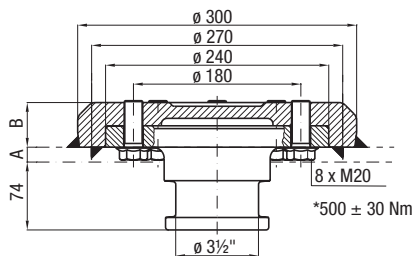

KZ 1516

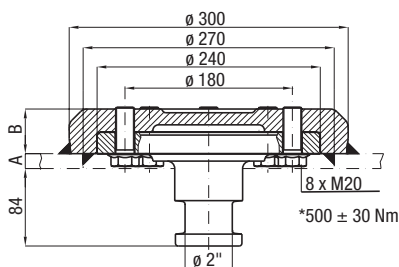

* Torque

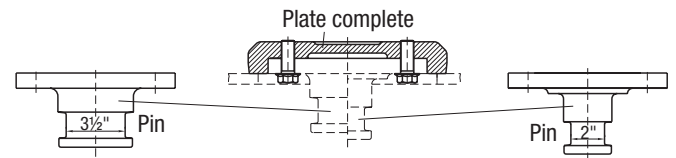

KZ 1016-01

KZ 1516-01

Selection table/Versions available

Order No. King pins, compl.	D value (kN)	A (mm)	B (mm)	Approval (ECE)
KZ 1516	170	16	48	E1 55R-01 0148
KZ 1016	320	16	48	E1 55R-01 0150

Delivery includes

- King pin complete with plate and screws (mounted)

KZ 10..., 14..., 15..., 28..

Spare parts

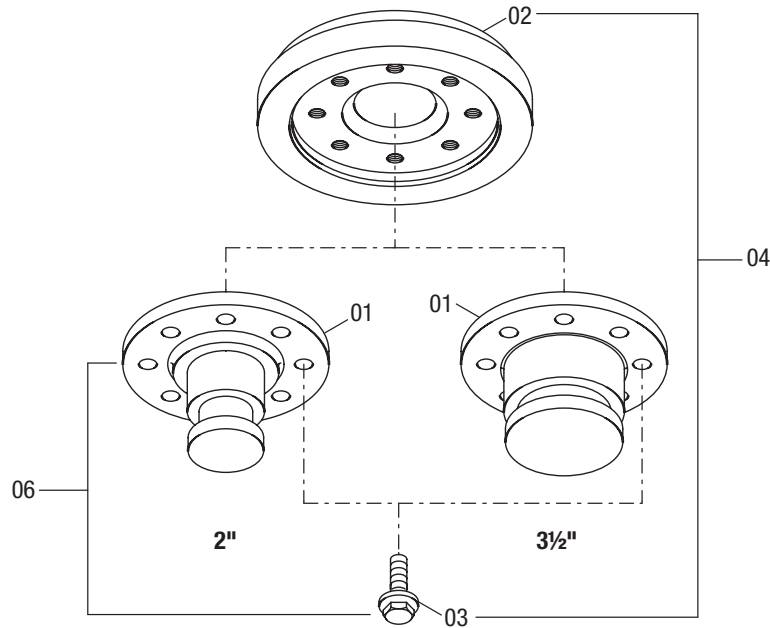

KZ 10..., KZ 14..., KZ 15..., KZ 28..

Item	Description	Remark	Order No.	per King pin
01	Pin	for KZ 1416	KZ 1416-01	1
01	Pin	for KZ 1016	KZ 1016-01	1
01	Pin	for KZ 2816	KZ 2816-01	1
01	Pin	for KZ 1516	KZ 1516-01	1
01	Pin	for KZ 1008, KZ 1010, KZ 1012	KZ 1012-01	1
01	Pin	for KZ 1410, KZ 1412	KZ 1412-01	1
02	Retention plate	for KZ 2816, KZ 1416	KZ 1416-02	1
02	Retention plate	for KZ 1012, KZ 1412	KZ 1012-02	1
02	Retention plate	for KZ 1010, KZ 1410	KZ 1010-02	1
02	Retention plate	for KZ 1008	KZ 1008-02	1
02	Retention plate	for KZ 1516, KZ 1016	KZ 1016-02	1
03	Bolt	for KZ 1516, KZ 1016	KZE 1016-06	8
03	Bolt	for KZ 2816, KZ 1416	KZE 1416-03	12
03	Bolt	for KZ 1008, KZ 1010, KZ 1012, KZ 1410, KZ 1412	KZE 1012-03	8
04	Retention plate (kit)	with 03 for KZ 1008	KZ 1008-04	1
04	Retention plate (kit)	with 03 for KZ 1010, KZ 1410	KZ 1010-04	1
04	Retention plate (kit)	with 03 for KZ 1012, KZ 1412	KZ 1012-04	1
04	Retention plate (kit)	with 03 for KZ 2816, KZ 1416	KZ 1416-04	1
04	Retention plate (kit)	with 03 for KZ 1516, KZ 1016	KZ 1016-04	1
05	Bolt kit (kit)	with 03 for KZ 1008, KZ 1010, KZ 1012, KZ 1410, KZ 1412	KZ 1012-006	1
06	Pin (kit)	with 03 for KZ 1008, KZ 1010, KZ 1012	KZ 1012-08	1